





140x140x51 mm

San Ace 140W 9WL type   

General Specifications

- Material Frame: Aluminum (Black coating), Impeller: Plastic (Flammability: UL 94V-0)
- Expected life See the table below. (L10 life: 90% survival rate for continuous operation in indoor free air at 60°C, rated voltage) Expected life at 40°C is for reference only.
- Motor protection function Locked rotor burnout protection, Reverse polarity protection
For details, please refer to p. 573.
- Dielectric strength 50/60 Hz, 500 VAC, for 1 minute (between lead wire conductors and frame)
- Insulation resistance 10 MΩ or more with a 500 VDC megger (between lead wire conductors and frame)
- Sound pressure level (SPL) At 1 m away from the air inlet
- Storage temperature -30 to +70°C (Non-condensing)
- Lead wire ⊕Red ⊖Black (Sensor) Yellow (Control) Brown
(For models without PWM control function, there is no speed control wiring.)
- Mass 930 g
- Ingress protection IP68

Specifications

The models listed below **have pulse sensors with PWM control function.**

Model no.	Rated voltage [V]	Operating voltage range [V]	PWM duty cycle* [%]	Rated current [A]	Rated input [W]	Rated speed [min ⁻¹]	Max. airflow [m ³ /min] [CFM]	Max. static pressure [Pa] [inchH ₂ O]	SPL [dB (A)]	Operating temperature [°C]	Expected life [h]		
9WL1412P5G001	12	10.2 to 13.8	100	5.16	62	7500	9.0 318	655 2.63	69	-20 to +70	100000/60°C (135000/40°C)		
			20	0.31	3.72	2300	2.75 97	80 0.32	38				
9WL1412P5S001			100	1.83	22	5000	6.0 212	295 1.18	57				
			20	0.31	3.72	2300	2.75 97	80 0.32	38				
9WL1424P5G001			24	20.4 to 27.6	100	2.58	62	7500	9.0 318			655 2.63	69
					20	0.16	3.84	2300	2.75 97			80 0.32	38
9WL1424P5S001	100	0.91			22	5000	6.0 212	295 1.18	57				
	20	0.16			3.84	2300	2.75 97	80 0.32	38				
9WL1448P5G001	48	40.8 to 55.2			100	1.29	62	7500	9.0 318			655 2.63	69
					20	0.12	5.76	2300	2.75 97			80 0.32	38
9WL1448P5S001			100	0.45	22	5000	6.0 212	295 1.18	57				
			20	0.12	5.76	2300	2.75 97	80 0.32	38				

* PWM input frequency is 25 kHz; models without specifications at 0% PWM duty cycle have zero fan speed at 0%.

The following sensor and control options are available for selection.

Differs according to the model. Refer to the table on p. 612. **Pulse sensor** **Lock sensor**

The models listed below **have pulse sensors.**

Model no.	Rated voltage [V]	Operating voltage range [V]	Rated current [A]	Rated input [W]	Rated speed [min ⁻¹]	Max. airflow [m ³ /min] [CFM]	Max. static pressure [Pa] [inchH ₂ O]	SPL [dB (A)]	Operating temperature [°C]	Expected life [h]
9WL1412A5001	12	10.2 to 13.8	2.61	31.4	5700	6.9 243.8	500 2	61	-20 to +70	100000/60°C (135000/40°C)
9WL1412H5001			1	12	4100	4.9 173.1	260 1.04	52		
9WL1412M5001			0.43	5.16	2600	3.1 109.5	100 0.4	40		
9WL1424A5001	24	20.4 to 27.6	1.21	29.10	5700	6.9 243.8	540 2.17	61		
9WL1424H5001			0.55	13.2	4100	4.9 173.1	260 1.04	52		
9WL1424M5001			0.23	5.52	2600	3.1 109.5	100 0.4	40		
9WL1448A5001	48	40.8 to 55.2	0.66	31.7	5700	6.9 243.8	540 2.17	61		
9WL1448H5001			0.31	14.9	4100	4.9 173.1	260 1.04	52		
9WL1448M5001			0.15	7.2	2600	3.1 109.5	100 0.4	40		

The following sensor and control options are available for selection.

Available for all models. **Without sensor** **Lock sensor**

Airflow - Static Pressure Characteristics / PWM Duty - Speed Characteristics Example

9WL1412P5G001 With pulse sensor with PWM control function

PWM duty cycle

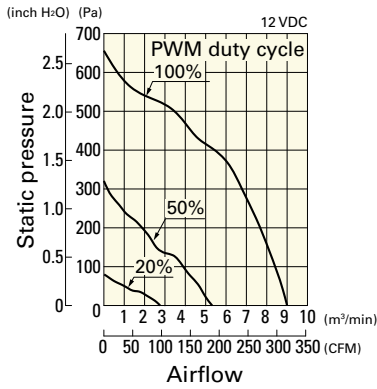

Operating voltage range

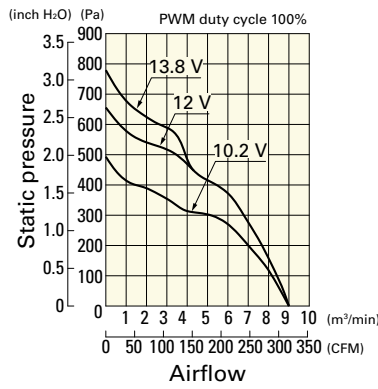

PWM duty - Speed characteristics example

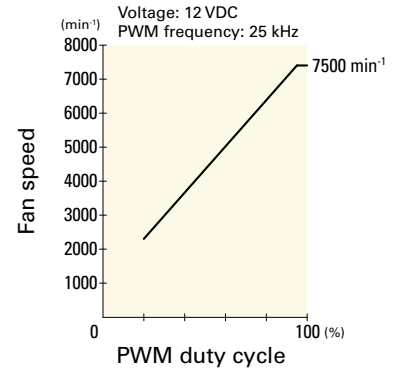

9WL1412P5S001 With pulse sensor with PWM control function

PWM duty cycle

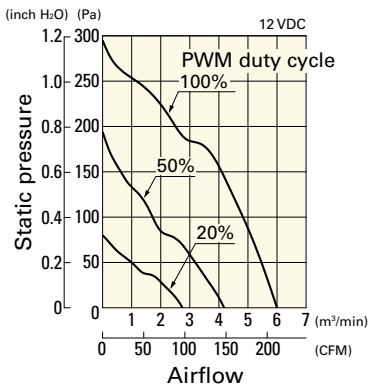

Operating voltage range

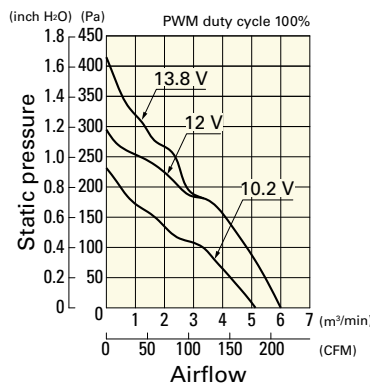

PWM duty - Speed characteristics example

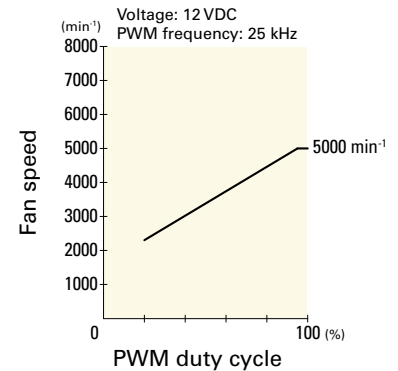

9WL1424P5G001 With pulse sensor with PWM control function

PWM duty cycle

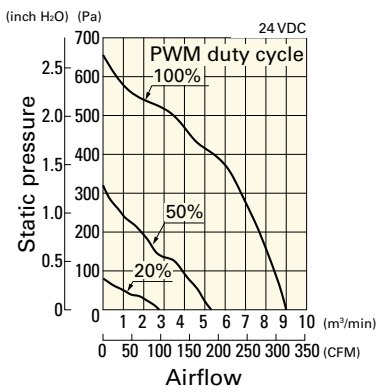

Operating voltage range

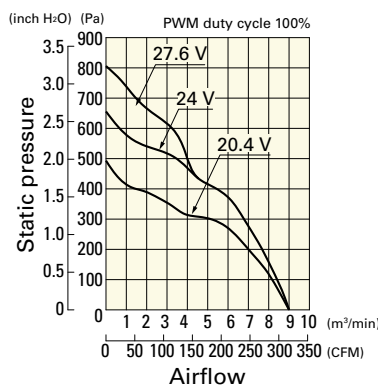

PWM duty - Speed characteristics example

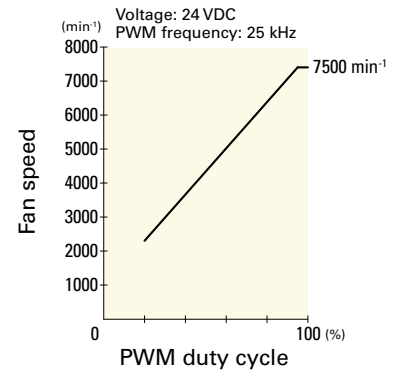

9WL1424P5S001 With pulse sensor with PWM control function

PWM duty cycle

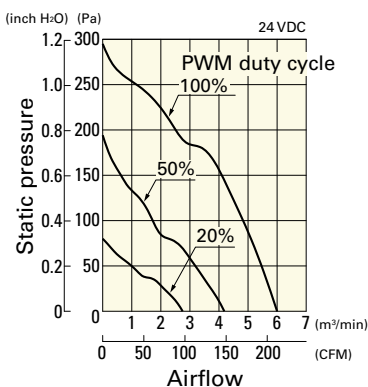

Operating voltage range

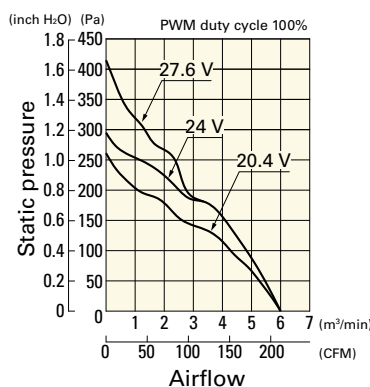

PWM duty - Speed characteristics example

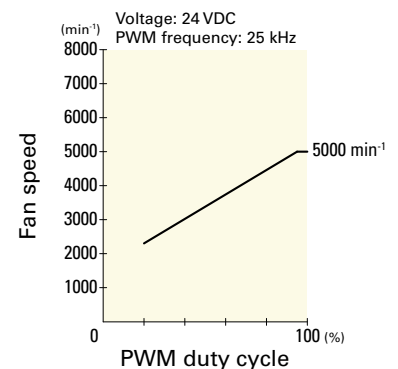

Airflow - Static Pressure Characteristics / PWM Duty - Speed Characteristics Example

9WL1448P5G001 With pulse sensor with PWM control function

PWM duty cycle

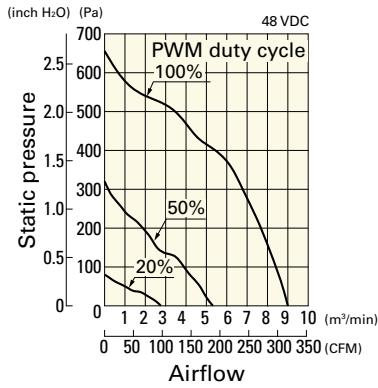

Operating voltage range

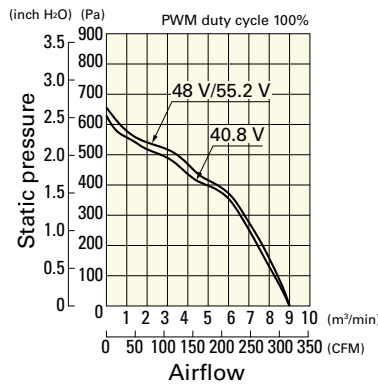

PWM duty - Speed characteristics example

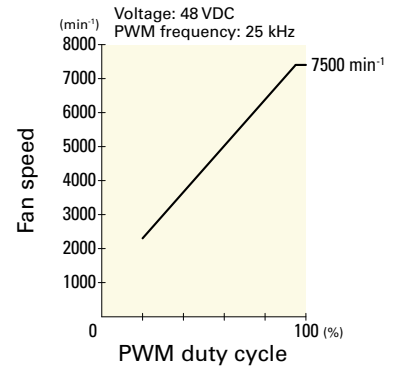

9WL1448P5S001 With pulse sensor with PWM control function

PWM duty cycle

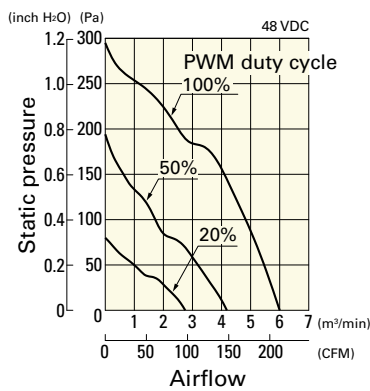

Operating voltage range

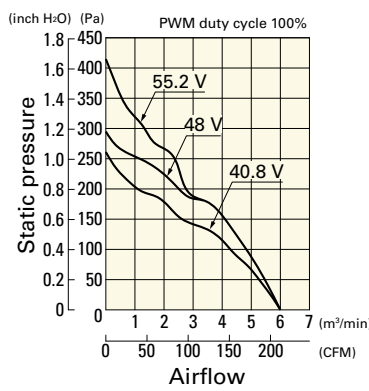

PWM duty - Speed characteristics example

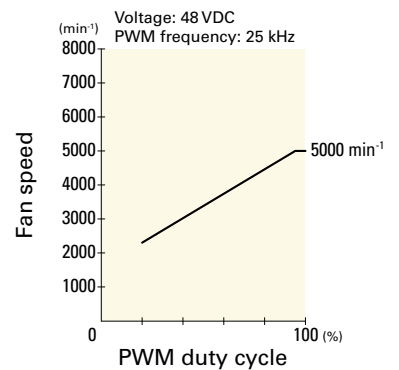

Airflow - Static Pressure Characteristics

9WL1412A5001 With pulse sensor

Operating voltage range

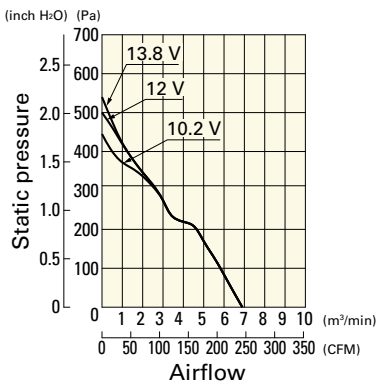

9WL1412H5001 With pulse sensor

Operating voltage range

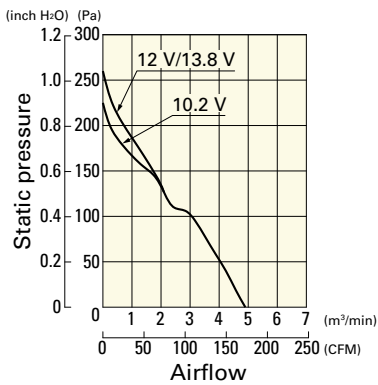

9WL1412M5001 With pulse sensor

Operating voltage range

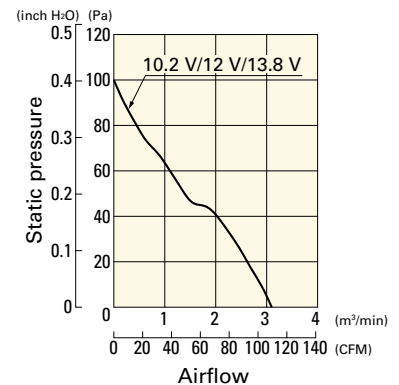

Airflow - Static Pressure Characteristics

9WL1424A5001 With pulse sensor

Operating voltage range

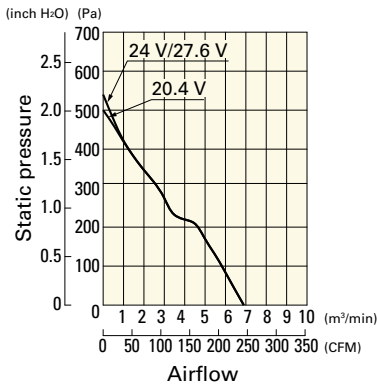

9WL1424H5001 With pulse sensor

Operating voltage range

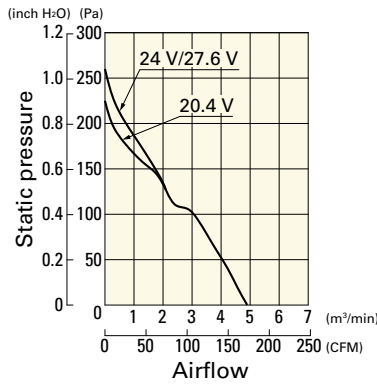

9WL1424M5001 With pulse sensor

Operating voltage range

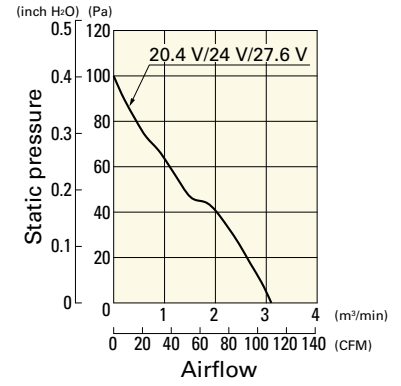

9WL1448A5001 With pulse sensor

Operating voltage range

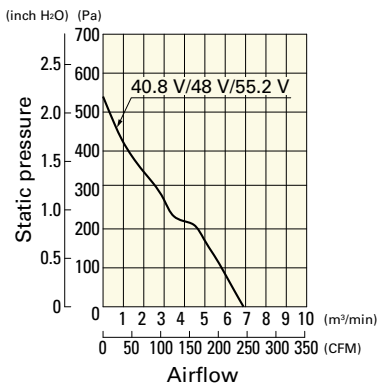

9WL1448H5001 With pulse sensor

Operating voltage range

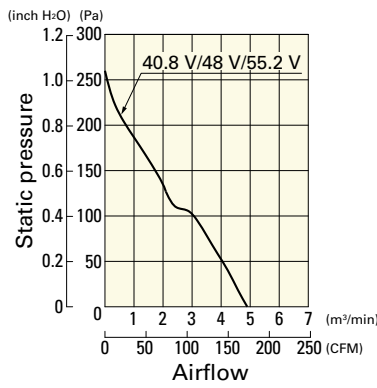

9WL1448M5001 With pulse sensor

Operating voltage range

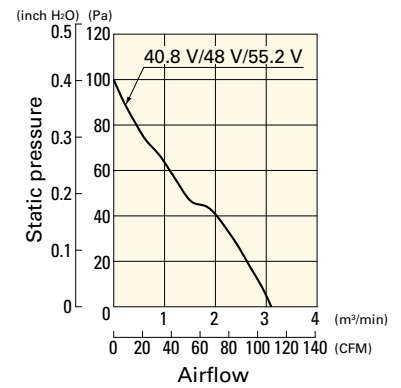

Dimensions (unit: mm)

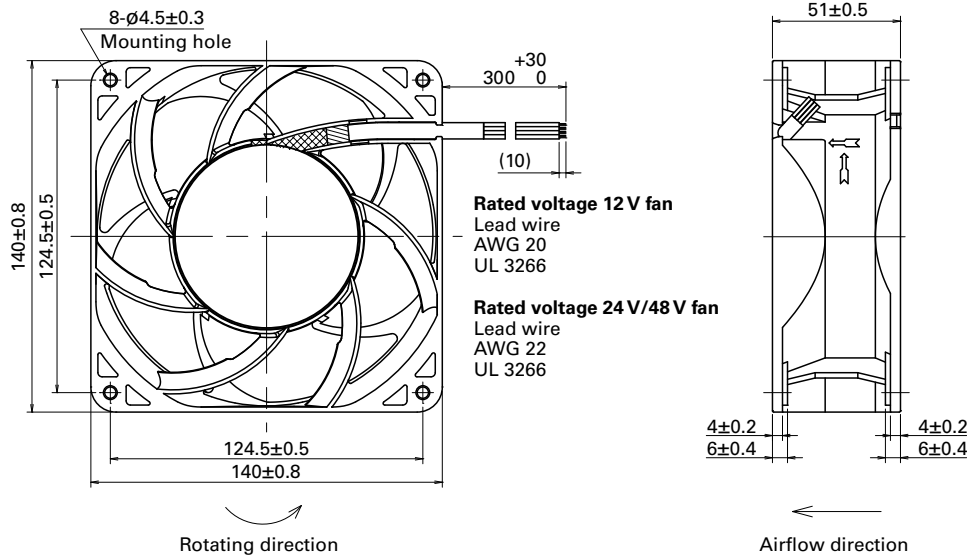

■ Reference Dimensions of Mounting Holes and Vent Opening (unit: mm)

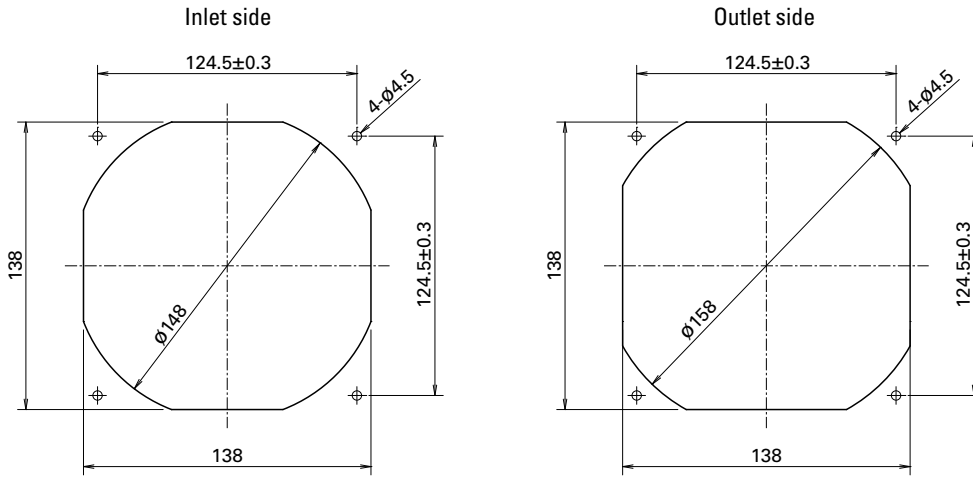

■ Options

Finger guards

page: p. 559

Model no.: 109-719, 109-719H