



60x60x25 mm

San Ace 60W 9WL type   US

General Specifications

- Material Frame: Aluminum (Black coating), Impeller: Plastic (Flammability: UL 94V-1)
- Expected life See the table below. (L10 life: 90% survival rate for continuous operation in indoor free air at 60°C, rated voltage) Expected life at 40°C is for reference only.
- Motor protection function Locked rotor burnout protection, Reverse polarity protection For details, please refer to p. 573.
- Dielectric strength 50/60 Hz, 500 VAC, for 1 minute (between lead wire conductors and frame)
- Insulation resistance 10 MΩ or more with a 500 VDC megger (between lead wire conductors and frame)
- Sound pressure level (SPL) At 1 m away from the air inlet
- Storage temperature -30 to +70°C (Non-condensing)
- Lead wire ⊕Red ⊖Black Sensor Yellow Control Brown
- Mass 120 g
- Ingress protection IP68

Specifications

The models listed below **have pulse sensors with PWM control function.**

Model no.	Rated voltage [V]	Operating voltage range [V]	PWM duty cycle [%]	Rated current [A]	Rated input [W]	Rated speed [min ⁻¹]	Max. airflow [m ³ /min] [CFM]	Max. static pressure [Pa] [inchH ₂ O]	SPL [dB (A)]	Operating temperature [°C]	Expected life [h]
9WL0612P4S001	12	10.8 to 13.2	100	0.67	8.04	11000	1.4 49.4	300 1.204	53	-20 to +70	180000/60°C (215000/40°C)
			20	0.06	0.72	2900	0.36 12.7	20.8 0.083	20		
9WL0612P4J001			100	0.39	4.68	8650	1.1 38.8	182 0.73	47		
			20	0.03	0.36	1150	0.13 4.8	3.3 0.013	14		
9WL0612P4H001			100	0.17	2.04	6150	0.78 27.5	97 0.389	36		
			20	0.03	0.36	1350	0.17 6.0	4.7 0.018	14		
9WL0624P4S001	24	21.6 to 26.4	100	0.34	8.16	11000	1.4 49.4	300 1.204	53		
			20	0.03	0.72	2900	0.36 12.7	20.8 0.083	20		
9WL0624P4J001			100	0.19	4.56	8650	1.1 38.8	182 0.73	47		
			20	0.02	0.48	2200	0.28 9.8	12.0 0.048	17		
9WL0624P4H001			100	0.08	1.92	6150	0.78 27.5	97 0.389	36		
			20	0.02	0.48	1300	0.16 5.6	4.3 0.017	14		

* PWM input frequency is 25 kHz; models without specifications at 0% PWM duty cycle have zero fan speed at 0%.

The following sensor and control options are available for selection.

Differs according to the model. Refer to the table on p. 611. Without sensor Pulse sensor Lock sensor

Airflow - Static Pressure Characteristics / PWM Duty - Speed Characteristics Example

9WL0612P4S001 With pulse sensor with PWM control function

PWM duty cycle

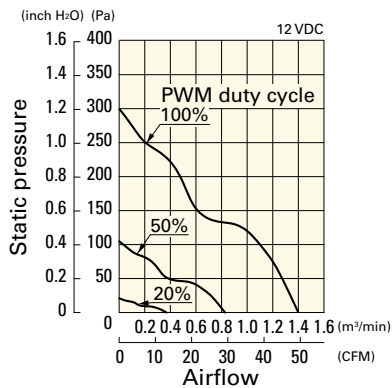

Operating voltage range

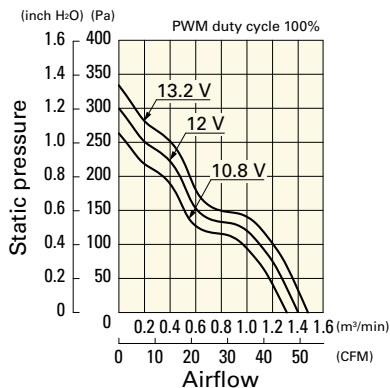

PWM duty - Speed characteristics example

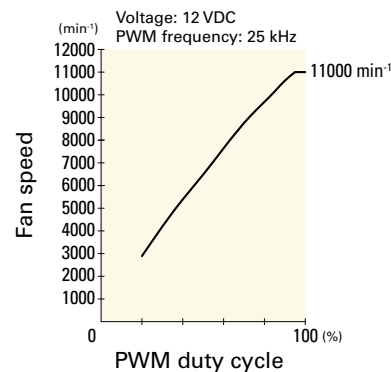

Airflow - Static Pressure Characteristics / PWM Duty - Speed Characteristics Example

9WL0612P4J001 With pulse sensor with PWM control function

PWM duty cycle

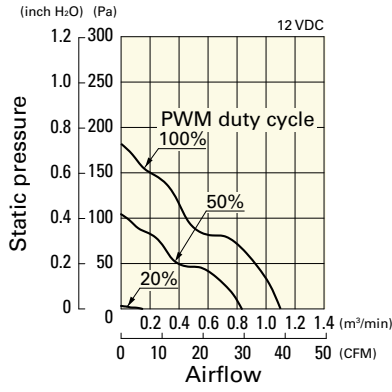

Operating voltage range

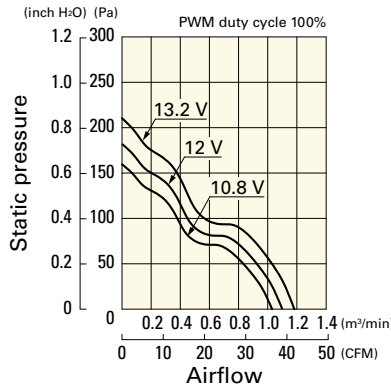

PWM duty - Speed characteristics example

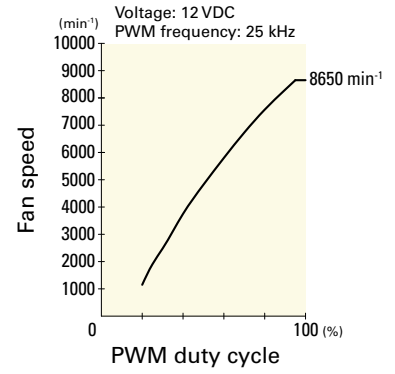

9WL0612P4H001 With pulse sensor with PWM control function

PWM duty cycle

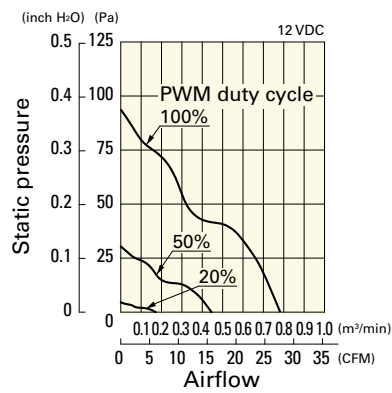

Operating voltage range

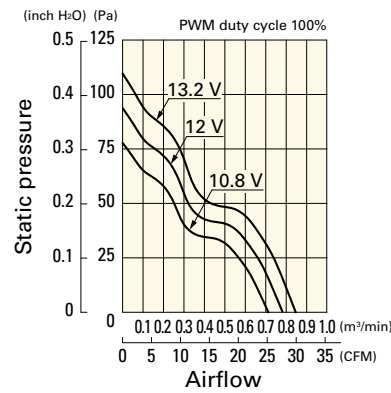

PWM duty - Speed characteristics example

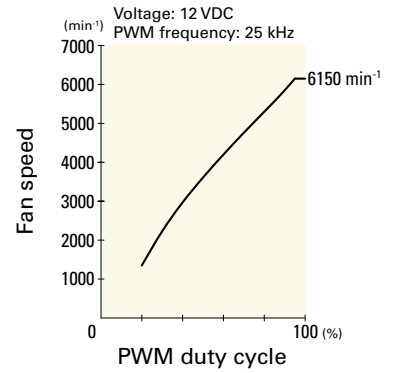

9WL0624P4S001 With pulse sensor with PWM control function

PWM duty cycle

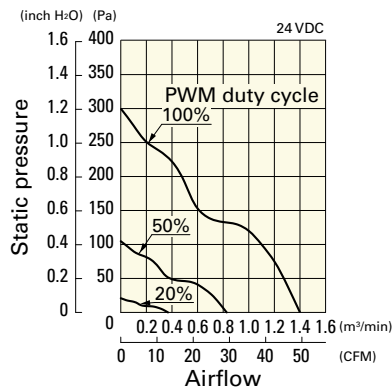

Operating voltage range

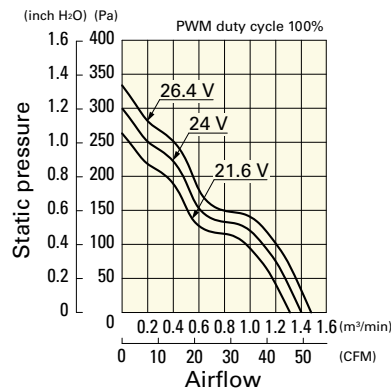

PWM duty - Speed characteristics example

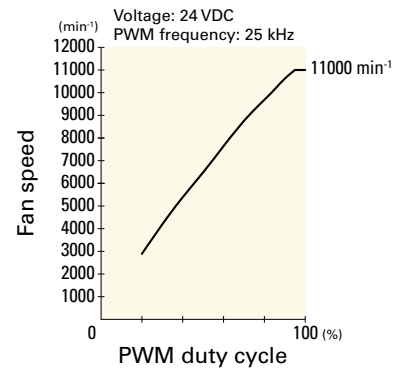

9WL0624P4J001 With pulse sensor with PWM control function

PWM duty cycle

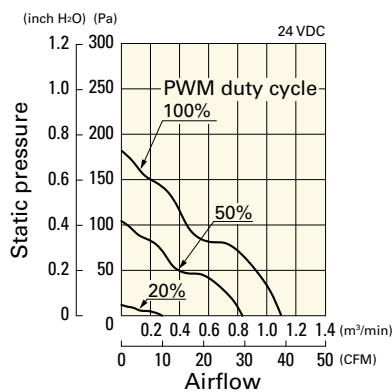

Operating voltage range

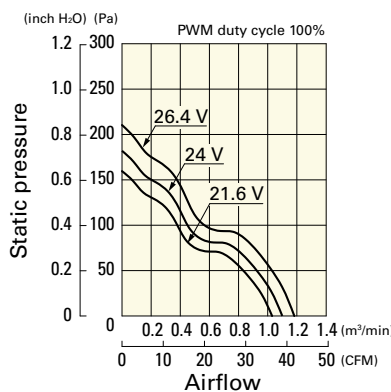

PWM duty - Speed characteristics example

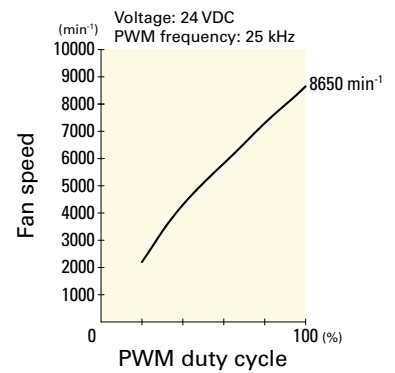

Airflow - Static Pressure Characteristics / PWM Duty - Speed Characteristics Example

9WL0624P4H001 With pulse sensor with PWM control function

PWM duty cycle

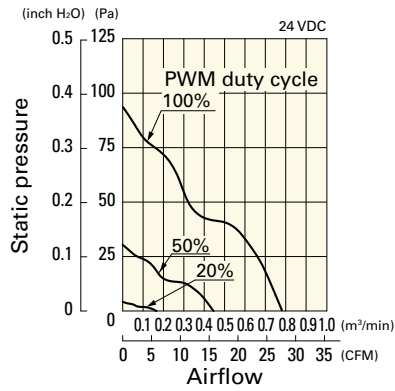

Operating voltage range

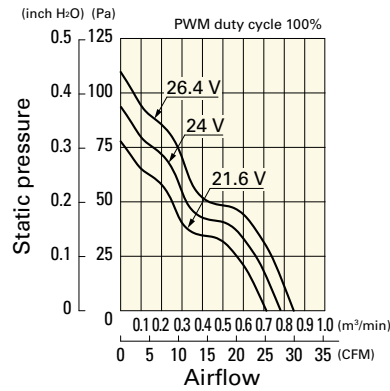

PWM duty - Speed characteristics example

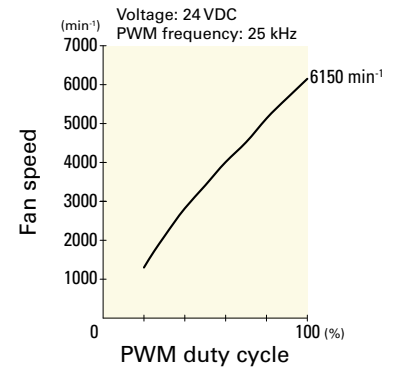

Dimensions (unit: mm)

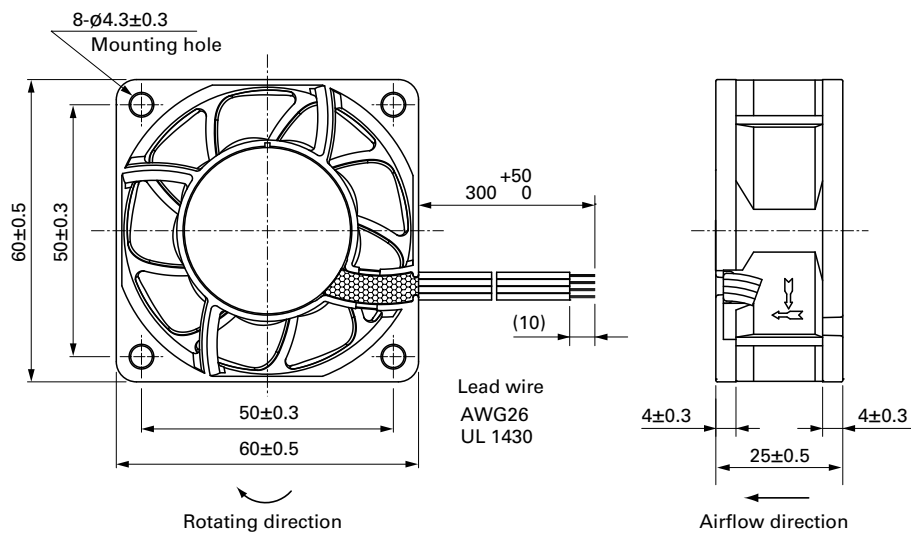

Reference Dimensions of Mounting Holes and Vent Opening (unit: mm)

Inlet side, Outlet side

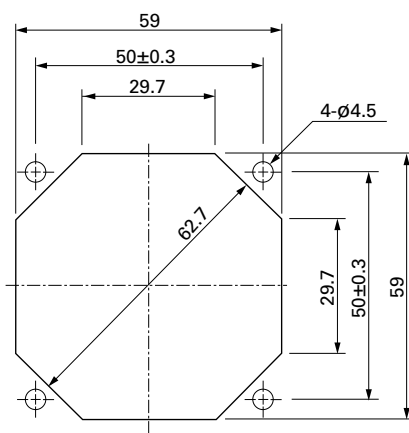

Options

Finger guards

page: p. 558

Model no.: 109-139E, 109-139H

Resin finger guards

page: p. 565

Model no.: 109-1003G

DC
Splash Proof Fan 60 mm sq.



60x60x25 mm

San Ace 60W 9WP type

DC
Splash Proof Fan 60 mm sq.

General Specifications

- Material Frame: Plastic (Flammability: UL 94V-0), Impeller: Plastic (Flammability: UL 94V-1)
- Expected life See the table below. (L10 life: 90% survival rate for continuous operation in indoor free air at 60°C, rated voltage)
Expected life at 40°C is for reference only.
- Motor protection function Locked rotor burnout protection, Reverse polarity protection
For details, please refer to p. 573.
- Dielectric strength 50/60 Hz, 500 VAC, for 1 minute (between lead wire conductors and frame)
- Insulation resistance 10 MΩ or more with a 500 VDC megger (between lead wire conductors and frame)
- Sound pressure level (SPL) At 1 m away from the air inlet
- Storage temperature -30 to +70°C (Non-condensing)
- Lead wire ⊕Red ⊖Black Sensor Yellow
- Mass 110 g
- Ingress protection IP68

Specifications

The models listed below **have ribs and pulse sensors**. For models without ribs, append "1" to the end of model numbers.

Model no.	Rated voltage [V]	Operating voltage range [V]	Rated current [A]	Rated input [W]	Rated speed [min ⁻¹]	Max. airflow [m ³ /min] [CFM]	Max. static pressure [Pa] [inchH ₂ O]	SPL [dB (A)]	Operating temperature [°C]	Expected life [h]	
9WP0612G401	12	10.2 to 13.2	0.21	2.52	5600	0.78 27.5	87.3 0.351	39	-20 to +60	40000/60°C (70000/40°C)	
9WP0612D401		10.2 to 13.8	0.21	2.52	5150	0.72 25	73.5 0.3	37		-20 to +70	60000/60°C (90000/40°C)
9WP0612H401			0.11	1.32	3800	0.53 18.7	40.2 0.161	28			
9WP0624J401	24	21.6 to 26.4	0.2	4.8	7600	1.06 37.1	155.0 0.622	44	-20 to +60	40000/60°C (70000/40°C)	
9WP0624G401		20.4 to 27.6	0.13	3.12	5600	0.78 27.5	87.3 0.351	39		-20 to +70	60000/60°C (90000/40°C)
9WP0624H401			0.06	1.44	3800	0.53 18.7	40.2 0.161	28			
9WP0648H401	48	40 to 53	0.04	1.92	3800	0.53 18.7	40.2 0.161	28	-20 to +70	60000/60°C (90000/40°C)	

The following sensor and control options are available for selection.

Differs according to the model. Refer to the table on p. 612. Without sensor Lock sensor PWM control

Airflow - Static Pressure Characteristics

9WP0612G401 With pulse sensor

Operating voltage range

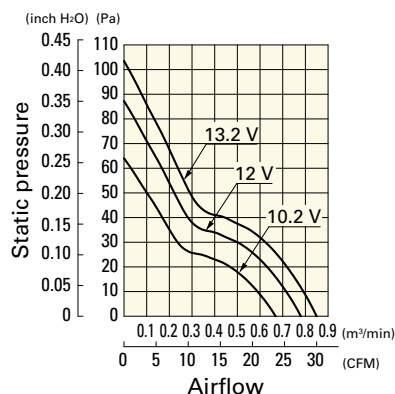

9WP0612D401 With pulse sensor

Operating voltage range

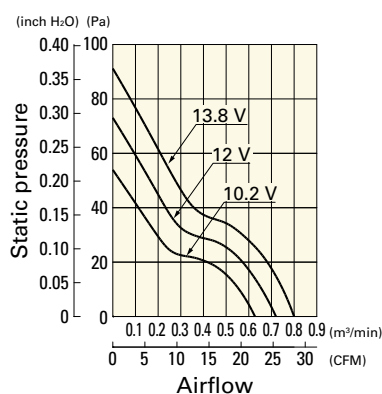

9WP0612H401 With pulse sensor

Operating voltage range

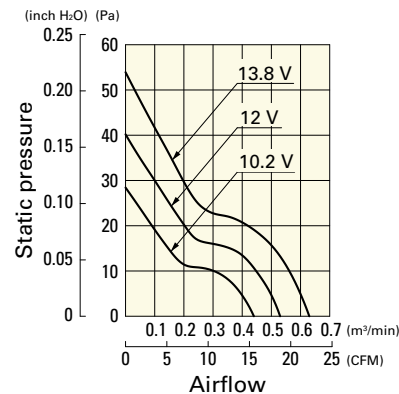

Airflow - Static Pressure Characteristics

9WP0624J401 With pulse sensor

Operating voltage range

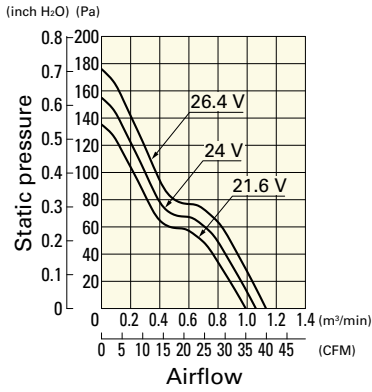

9WP0624G401 With pulse sensor

Operating voltage range

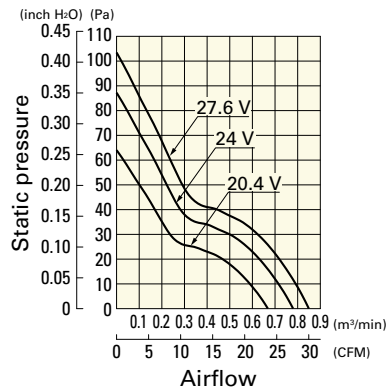

9WP0624H401 With pulse sensor

Operating voltage range

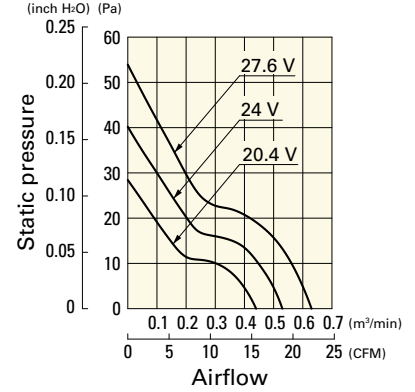

9WP0648H401 With pulse sensor

Operating voltage range

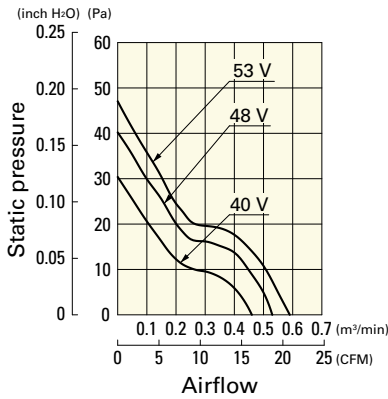

Dimensions (unit: mm) (With ribs)

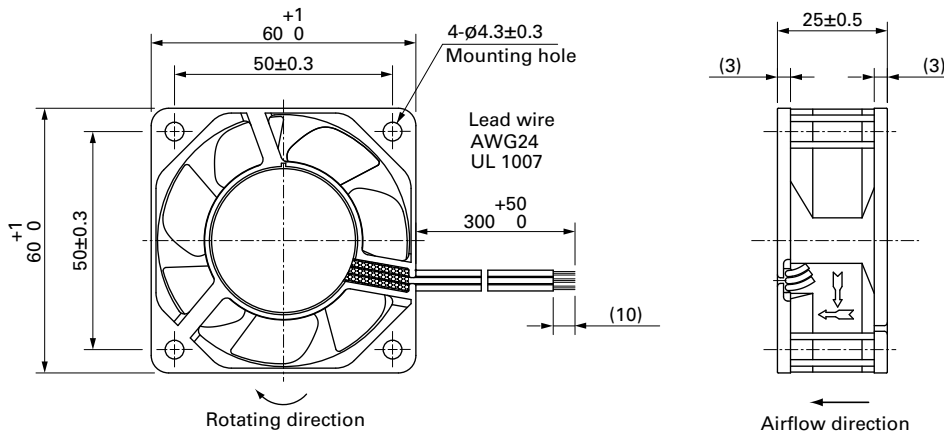

Reference Dimensions of Mounting Holes and Vent Opening (unit: mm)

Inlet side, Outlet side

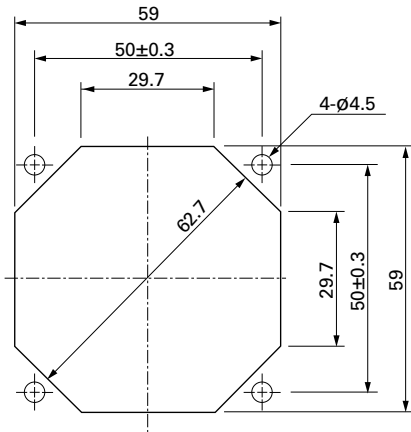

Options

Finger guards

page: p. 558

Model no.: 109-139E, 109-139H

Resin finger guards

page: p. 565

Model no.: 109-1003G